

INSTALLATION, OPERATION AND MAINTENANCE MANUAL

Magdrive

Linear actuator

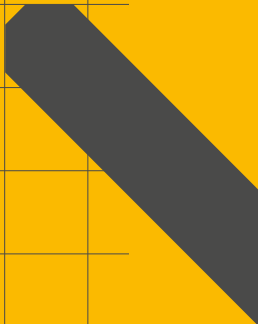

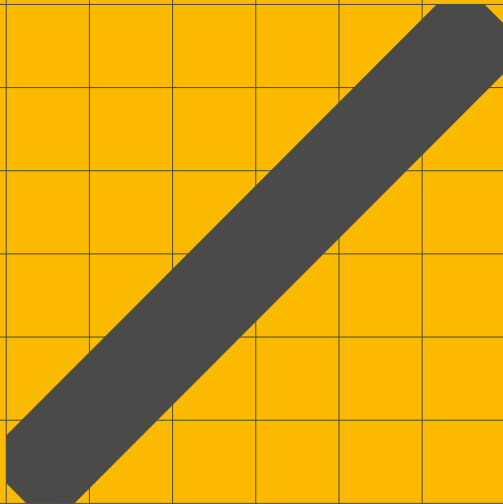

Contents

1.0 General information	4	5.0 Normal operation	13
1.1 Information on this manual	4	5.1 Preconditions for operation	13
1.2 Explanation of symbols and signal words.....	4	5.2 Switch on linear actuator	13
1.3 Limitation of liability	5	5.3 Emergency shutdown	13
1.4 Warranty terms	5	6.0 Installation and initial start-up	14
1.5 Customer service.....	5	6.1 Preparation.....	14
2.0 Basic principle	6	6.1.1 Transport.....	14
2.1 Operating instructions	6	6.1.2 Check items in shipment	14
2.1.1 Validity.....	6	6.1.3 Power supply	14
2.1.2 Target audience and obligation to read.....	6	6.2 Installation and connections.....	14
2.1.3 Summary of contents	7	6.2.1 Set-up and adjustment	14
2.1.4 Aids for accessing information	7	6.2.2 Interfaces and connections	15
2.2 Organizational measures	7	6.2.3 Installation.....	15
2.3 Conventions	7	6.3 Initial start-up.....	15
2.3.1 Warnings and usage hints	7	6.3.1 Installation check	15
2.3.2 Position numbers and references	7	6.3.2 Initial start-up.....	15
2.3.3 Type plate.....	7	7.0 Maintenance, clearing malfunctions, repairs	16
2.0 Safety	8	7.1 Maintenance	16
3.1 Purpose of use of the MAGDRIVE	8	7.1.1 Maintenance plan	16
3.2 Intended Use.....	8	7.1.2 Cleaning	16
3.3 Unauthorized use.....	8	7.2 Malfunctions	16
3.4 User groups	8	7.2.1 Recognizing malfunctions	18
3.5 Types of operation	9	7.3 Repair.....	18
3.6 Danger zones	9	8.0 Removing from service, dismantling and disposal	19
3.7 Areas of responsibility	9	8.1 Shutting down.....	19
3.8 General safety notice.....	9	8.2 Dismantling	19
3.9 Other hazards	9	8.3 Storage.....	19
3.9.1 Residual hazards to people, objects and property.....	10	8.4 Disposal	19
4.0 Structure and function	11	9.0 Appendix	20
4.1 Construction	11	9.1 Technical data.....	20
4.1.1 Overall view MAGDRIVE	11	9.1.1 Equipment and operating data.....	20
4.1.2 Operating elements	11	9.1.2 Ambient conditions.....	20
4.2 Function	11	9.2 Plans and diagrams	20
4.2.1 Functional principles.....	11	9.3 Standards applied	20
4.3 Options and accessories.....	12		
4.3.1 Options.....	12		
4.3.2 Accessories.....	12		

⚠ WARNING

Read this manual before installing, operating or maintaining this actuator. Failure to follow safety precautions and instructions could cause actuator failure and result in serious injury, death or property damage.

1.0 General information

1.1 Information on this manual

This manual provides important information on how to work with the actuators safely and efficiently.

The manual is part of the actuator, must always be kept in the actuator's direct proximity and should be available for the personnel at any time. All personnel working with the actuator must read and understand this manual before starting any work. Strict compliance with all specified safety notes and instructions is a basic requirement for safety at work.

Moreover, the accident prevention guidelines and general safety precautions applicable at the place of use of the actuator must also be complied with.

For better representation of circumstances, the illustrations used are not necessarily to scale and may vary from the actual design of the actuator.

1.2 Explanation of symbols and signal words

Safety precautions

Safety precautions are identified by symbols and signal words. These signal words indicate the severity of the hazard.

Adhere to these safety precautions and act cautiously in order to avoid accidents, personal injuries and damage to property.

DANGER

Indicates a dangerous situation, which will lead to death or serious personal injury, if the precautionary measures are ignored.

WARNING

Indicates a dangerous situation, which can lead to minor or moderate injury or property damage, if the precautionary measures are ignored.

CAUTION

Indicates a dangerous situation, which can lead to minor or moderate injury if the precautionary measures are ignored.

NOTICE

Indicates information considered important, but not hazard-related (e.g. messages relating to property damage).



NOTE

Emphasizes useful hints and recommendations as well as information for efficient and trouble-free operation.

1.3 Limitation of liability

All information and notes in this manual were compiled under due consideration of valid standards and regulations, the present status of technology and our years of knowledge and experience.

The manufacturer will not be liable for damage resulting from:

- disregarding this manual
- unintended use
- employment of untrained personnel
- unauthorized conversions
- technical modifications
- manipulation or removal of the screws on the actuator
- use of unapproved spare parts

In case the actuator is customised, the actual product delivered may be different from what is described in the manual. In this case, ask Ewellix for any additional instructions or safety precautions relevant to these actuators.

We reserve the right to make technical modifications to the actuator to improve usability.

1.4 Warranty terms

The applicable and effective warranty terms are those contained in the manufacturer's terms and conditions of sale.

1.5 Customer service

Ewellix Customer Service is always available to provide technical information and answer questions.

The contact information for Ewellix Customer Service can be found on www.ewellix.com.

2.0 Basic principle

This chapter contains information on the organization and structure of the operating instructions. It makes the instruction manual easier to handle and enables quick access to the desired information.

2.1 Operating instructions

Ewellix manufactures state of the art electric motors.

The purpose of these operating instructions is to introduce you, as the user and the entity doing the further processing, to correct utilization and safe use.

For this goal to be achieved, it is essential that you very carefully read the chapter on safety (↳ **3.0 Safety, page 8**) and follow the instructions in this manual.

2.1.1 Validity

The instructions in this manual refer to the linear actuator MAGDRIVE™ with the following identification:

- Manufacturer: Ewellix, Liestal
- Product name: Linear actuator MAGDRIVE™
- Type designation: MD
- Year of manufacture: from 2005
- CE Mark: according to technical documentation
- Serial number: from production start

2.1.2 Target audience and obligation to read

These operating instructions are intended for technical personnel and authorized users who use the linear actuator MAGDRIVE™ in their products and work with it. The operating authority determines who is authorized as a user.

We distinguish between different user groups, as the requirements on the users vary, depending on the activity they perform.



NOTE

You can find definitions of user groups along with their corresponding requirements in the chapter on safety (↳ **3.0 Safety, page 8**). You can assume one or more of these user groups provided you meet the applicable requirements.

The organization and implementation of the operating instructions takes into account the different user groups.

2.1.3 Summary of Contents

The operating instructions serve as a reference work. The information therein is organized into four task- and theme-related parts:

Basic Principles

The Basic Principles section gives the basic knowledge that every user should have.

Normal Operation

The Normal Operation section contains information needed for operating the product under normal conditions, i.e. uninterrupted operation for use according to its intended application.

Special Operations

The Special Operations section describes all jobs deviating from normal operation, such as installation, initial start-up, maintenance, fixing faults and carrying out repairs.

Appendix

The Appendix contains information that the user has to be able to access at any time.

This includes information on using the operating instructions (indexes) as well as data concerning the product itself (technical data).

2.1.4 Aids for accessing information

This manual has access aids that make it easier for you to quickly access the desired information:

- you can most easily find all information on a given topic in the Table of Contents,
- as a result of the task and theme-related organization of the operating instructions.
- Information on a specific activity or a special topic can be found most quickly
- through the Index.
- within the chapters of the operating instructions, you can orient yourself with the
- help of the margin notes.

2.2 Organizational Measures

If you have any questions that cannot be answered through these operating instructions, contact the manufacturer directly.

Location of the Operating Instructions

The operating instructions can only benefit you if you have them available at all times. For this reason, always keep the operating instructions where the equipment is being used.

Manufacturer address Ewellix Switzerland AG

Oristalstrasse 97

CH-4410 Liestal

Tel.: +41 / 61 / 925 41 11

Fax: +41 / 61 / 921 37 04

E-mail: actuators.switzerland@Ewellix.com

Contact address

Your local Ewellix representative.

2.3 Conventions

In this manual we use a few abbreviations and markings to label sections of text or notes.

In the following sections you will find these conventions explained.

2.3.1 Warnings and Usage Hints

Please note the meaning of the following warnings and usage hints:



NOTE

Indicates usage information that helps the user to use the product correctly and efficiently or to understand the properties of the product.

CAUTION

Warning to inform the user of hazards that remain due to the incomplete effectiveness of protective measures for property damage or personal injury; points out any special training and personal protective equipment that may be required.

WARNING

Warning of irreparable property damage or personal injury that remain based on hazard analysis. With reference to protective measures and any special training and personal protective equipment that may be required.

2.3.2 Position Numbers and References

Position numbers

We number diagram parts clockwise in serial order and unambiguously.

Cross-references to text passages

Cross-references to chapters or diagrams are given in parentheses. They contain the corresponding chapter or diagram number.

2.3.3 Type plate

Find the following symbols on the type plate:



Please observe the accompanying documents



Electrical and electronic appliances have to be collected separately and must not be disposed of with household waste

3.0 Safety

This chapter is intended for all users of the MAGDRIVE™ linear actuator. It contains information on its safe use and optimal utilization.

The safety program from Ewellix spells out who is entitled to use it and the responsibility of individual users.

The MAGDRIVE™ was designed and built in accordance with the latest technical standards and accepted safety rules.

CE-conformity is documented with the technical documentation.

3.1 Purpose of use of the MAGDRIVE™

The linear actuator MAGDRIVE™ has been designed and built to be operated in accordance with its intended use. If you use the MAGDRIVE™ for any use other than that cited, the manufacturer cannot be held responsible for damage resulting from this.

The MAGDRIVE™ has been designed for interior applications in the industrial, medical and building services engineering sectors.

3.2 Intended Use

The intended use of the MAGDRIVE™ is:

- MD22/24: dynamically centered pressured lifting
- MD23/25: dynamically centered pressured or tension-stressed lifting



NOTE

For the operations data, please see the Appendix of this operating manual (↳ **9.1.1 Equipment and operating data, page 20**) and associated datasheets.

3.3 Unauthorized use

Any use other than the intended use without the manufacturer's written agreement or operation beyond the technical limits is considered unauthorized.

You can find the technical operating limits in the appendix (↳ **9.1 Technical data, page 20**) of this manual, the associated datasheets and on the type plate of the MAGDRIVE™.



NOTE

Any unauthorized use of the MAGDRIVE™ can cause personal injury and property damage. Always adhere to the instructions of this manual.

3.4 User groups

To ensure safety, we place requirements on the users of the MAGDRIVE™ that must be adhered to under all circumstances. Only persons who meet the requirements are entitled to use the MAGDRIVE™.

We refer to all persons who operate, use, commission the linear actuator, process it further or pass it on for further processing as user groups. As the requirements of these user groups strongly depend on their role, we distinguish between the following user groups:

Operating Authority

The operating authority is the contractual partner of the person doing the further processing or the reseller. They can impose legal conditions on the operating authority when purchasing the linear actuator. The operating authority ensures that the user is instructed in the authorized use of the equipment.

Processor

The processor is the contractual partner of the reseller or the manufacturer. He assembles the linear actuator into a complete device. He is authorized by the manufacturer to use the linear actuator MAGDRIVE™ in accordance with the regulations and has the necessary expert knowledge.

Technician

The technician has the professional technical training to utilize the linear actuator MAGDRIVE™ according to its authorized use. Apart from the chapter on Safety, he is also familiar with the chapter on Special operating modes. He will find the required technical data in the Appendix.

Reseller

The reseller forwards the machine.

Operator

Any other person who uses the MAGDRIVE™ is defined as an operator. The operator must have read the Safety chapter in this manual before using the machine. Moreover, he must be instructed about normal operation by the operating authority.

3.5 Types of operation

Intermittent

The linear actuator MAGDRIVE™ is only to be used for intermittent operation (↳ **9.1 Technical data, page 20**).

3.6 Danger zones

We differentiate between two danger zones that must be observed, depending on the user role.

Persons

The danger zone covering persons also includes, in addition to the actual user, third persons (other personnel, visitors, patients etc.). In case of injury, the operating authority is liable.

Device

The danger zone device comes under the Processor and Technician user groups and covers the linear actuator MAGDRIVE™ and any elements that have been attached.

3.7 Areas of responsibility

Different areas of responsibility, corresponding to the different user groups, arise.

Operating Authority

The operating authority bears the responsibility for the danger zone covering persons and ensures that only authorized and trained users work with the MAGDRIVE™. He or she is responsible for the following:

- Identifying the persons who are allowed to use the MAGDRIVE™ (authorized persons)
- Instructing the user groups

- Complying with all relevant legal conditions and regulations



NOTE

The operating authority may only authorize persons to use the MAGDRIVE™ who meet the requirements for the user groups.

Processor

The processor is responsible for the following

- Forwarding an CE-conformant operating manual for the device in which the linear actuator MAGDRIVE™ is installed
- Adherence to the safety regulations in accordance with this operating manual

Reseller

The reseller is responsible for the following:

- Forwarding this operating manual and the linear actuator MAGDRIVE™ to the processor or
- forwarding an CE-conformant operating manual and the device in which the linear actuator MAGDRIVE™ is installed to the operating authority

Technician

The technician is responsible for the following:

- Observing the manufacturer's instructions and the safe set-up of interfaces with other equipment.
- Installation and use of the MAGDRIVE™ in accordance with its intended use
- Installation of optional modules and connecting cables

Operator

The operator ensures that nobody will be endangered when the MAGDRIVE™ is running. He or she is, in particular, responsible for

- Operating the MAGDRIVE™ in normal operating conditions
- Immediate and appropriate reaction to malfunctions

3.8 General safety notice

The linear actuator is suitable for internal use only and must not be exposed to weathering, strong UV radiation or corrosive or explosive atmospheric media, or other aggressive media (↳ **8.0 Appendix, Ambient conditions, page 18**).

3.9 Other hazards

The manufacturer has constructively, and with protective measures, minimized the effects of existing residual hazards. Pay attention to the residual hazards and the potential countermeasures given in the following chapters.

3.9.1 Residual hazards to people, objects and property

Pay attention to the following residual hazards and the possible countermeasures for dealing with them MAGDRIVE™:

⚠ WARNING

Risk of hand injuries when the motor is running due to clamping on the push tube's fork head. If the fork head is not installed in the device there is a turning movement. Do not let any object or person come into contact with the push tube's fork head while the motor is running. Hold the MAGDRIVE™ only by the tube casing.

⚠ WARNING

Warning for risk of crushing and damage to the MAGDRIVE™ caused by static and dynamic overloading of the linear actuator. When driving against fixed objects the impact of the force can cause personal injury. Make sure that there are no persons or fixed objects present in the danger zone during the stroke.

- Note the maximum permissible operating data in the Appendix (↳ **9.1.1 Equipment and operating data, page 20**) or the associated datasheets
- Note the type plate of the linear actuator

⚠ WARNING

Warning of side-acting forces. Excessive side-acting forces destroy the drive and pose a danger to persons. During the stroke, do not manipulate any of the elements that are connected to the MAGDRIVE™.

⚠ CAUTION

Please note that the MAGDRIVE™ can be damaged by water or other fluids. MAGDRIVE™ is only protected to IPX0 or, as an option, IPX4S (sprayed water). In any case, the MAGDRIVE™ must be prevented from being exposed to sprayed water when moving in or out.

⚠ CAUTION

Be aware that the MAGDRIVE™ can be destroyed by overheating. The MAGDRIVE™ is designed for intermittent use. If used improperly >10% ED the linear actuator can be destroyed and there may be damage to property. Adhere strictly to operating and standstill times.

- Use a control unit with an integrated thermo-switch.
- Please refer to the appendix (↳ **9.1.1 Equipment and operating data, page 20**) or associated datasheets.

4.0 Structure and function

This chapter is intended for all users of the MAGDRIVE™. It shows its construction and explains its function.

4.1 Construction

The following figure will give you an overview of the linear actuator.

4.1.1 Overall view MAGDRIVE™

Fig. 1

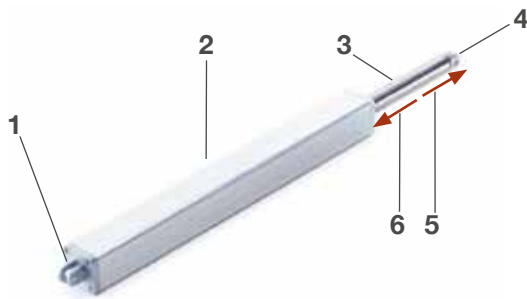

Overall view MAGDRIVE™

1. Hinge head on the engine casing
2. Tube casing / Motor casing
3. Push tube
4. Fork head of the push tube
5. Direction of movement when moving out
6. Direction of movement when moving in

4.1.2 Operating elements

The Ewellix operating elements are available as accessories for the MAGDRIVE™ and the Ewellix control unit. If you have any questions, please consult the corresponding operating manuals for these devices.

4.2 Function

A description of its function allows you to understand what the linear actuator and its individual parts do.

4.2.1 Functional principles

The operating principle of the linear actuator MAGDRIVE™ MD22/24 is based on pressure only (tension stress is only permitted for transport purposes and limited in line with operating data (↳ **9.1.1 Equipment and operating data, page 20**)).

The operating principle of the linear actuator MAGDRIVE™ MD23/25 is based on tension stress or pressure. MD23/25 must not be operated with alternating load (↳ **9.1.1 Equipment and operating data, page 20**)).

The built-in brake decelerates the movement or holds the position at a standstill (↳ **Fig. 1, pos. 5 and 6, page 11**). No lateral pressure or turning movement may be caused.

The linear drive MAGDRIVE™ must be equipped with a Ewellix control unit and operating unit.

Tube casing / motor casing (2)

The tube casing / motor casing as the load-bearing component with an integrated engine, gear and linear unit. The power cable (motor cable with low-voltage plug) is firmly installed in the tube casing / motor housing. At the lower end of the tube casing a hinge head is fixed; this is used to move the actuator to the application on one side.

Motor unit

The permanent magnet motor is a 24 V DC motor that drives the planetary gear via the motor shaft. The speed of the thrust depends on the load.

Drives

The planetary gear is driven directly by the motor shaft which moves a worm gear.

Linear unit

The linear unit / the push tube is integrated into the tube casing / motor casing. The planetary gear drives the spindle nut into a linear movement. If the spindle nut breaks an integrated safety nut protects the push tube from also breaking. An in and out movement is executed via the push tube. The push tube is surrounded by the tube casing / motor casing (2) and protected by it. The base of the push tube is connected with the worm gear via the spindle nut, at the top is the fork head (4) of the push tube (3).

Thermo-switch

The linear drive MAGDRIVE™ does not have any thermal protection and can be damaged by overheating. For this reason a control unit with an integrated thermo-switch must be used. This switches the MAGDRIVE™ off in an emergency. The linear actuator must not be operated until the drive temperature has fallen below the switching threshold.

Brake

The brake is attached to the spindle, its purpose is to decelerate the planetary gear and support the self locking.

End switch

The linear actuator is equipped with internal end switches that switch off the linear actuator at the end positions. If the end switches fail the linear actuator moves to one of the two buffers attached to each side if a serious error occurs, blocks and releases the current cut off integrated into the control unit or removes the power from the linear actuator.

4.3 Options and accessories

4.3.1 Options

Options can be recognized from the type designation on the type plate.

Emergency lowering

For applications where lowering takes place mechanically in an emergency it is possible to equip the linear actuator with an optional emergency lowering device. Then it is possible, if for example the power fails or there are drive errors, to lower the application manually (↳ **5.3 Emergency Shutdown, page 13**) section.

Electrical anti pinching protection

The electrical anti pinching protection is an electrical switch that switches the linear actuator off when moving in (6) if the stroke is hindered by an object or body part. This protection does not work when moving out (5).

Encoder

With the Hall sensor, the encoder picks up impulses from a magnetic disk located on the motor shaft.

IPX4S

The linear actuator MAGDRIVE™ may be supplied as an option with protection class IPX4S. This protects the MAGDRIVE™ against sprayed water (↳ **5.0 Normal Operation, page 13**).

4.3.2 Accessories

Control unit

The linear actuator MAGDRIVE™ requires a Ewellix control unit to power the motor. Only use Ewellix control units.

Operating elements

The linear actuator MAGDRIVE™ can be operated remotely by a Ewellix operating element on the control unit. Only use Ewellix operating elements.

IMPORTANT: Ewellix will not accept liability for any damage caused if the linear actuator MAGDRIVE™ is not used with a suitable Ewellix control unit / operating element.

5.0 Normal operation

This chapter is directed at the user groups operator and operating authority. It provides all the information required for the safe and smooth operation of the linear actuator under normal operating conditions.

In normal operation the linear actuator lifts or lowers elements which are connected to the MAGDRIVE™ via the fork head and hinge head.

5.1 Preconditions for operation

A Ewellix control unit controls the MAGDRIVE™ (↳ 4.3.2 Accessories, page 12).

5.2 Switch on linear actuator

⚠ WARNING

Warning for risk of crushing and damage to the MAGDRIVE™ caused by static and dynamic overloading of the linear actuator. When driving against fixed objects the impact of the force can cause personal injury. Make sure that there are no persons or fixed objects present in the danger zone during the stroke.

- Note the maximum permissible operating data in the Appendix (↳ 9.1.1 Equipment and operating data, page 20) and associated datasheets
- Note the type plate of the linear actuator

⚠ WARNING

Warning of side-acting forces. Excessive side-acting forces destroy the drive and pose a danger to persons. During the stroke, do not manipulate any of the elements that are connected to the MAGDRIVE™.

⚠ CAUTION

Be aware that the MAGDRIVE™ can be destroyed by overheating. The MAGDRIVE™ is designed for intermittent use. If used improperly >10% ED the linear actuator can be destroyed and there may be damage to property. Adhere strictly to operating and standstill times.

- Use a control unit with an integrated thermo-switch.
- Please refer to the appendix (↳ 9.1.1 Equipment and operating data, page 20) or associated datasheets.

⚠ CAUTION

Please note that the MAGDRIVE™ can be damaged by water or other fluids. MAGDRIVE™ is only protected to IPX0 or, as an option, IPX4S (sprayed water). In any case, the MAGDRIVE™ must be prevented from being exposed to sprayed water when moving in or out.

The Ewellix control unit must be connected to mains electricity. It is operated by a Ewellix operating element (↳ 4.3.2 Accessories, page 12).

Emergency lowering

For applications with emergency lowering in special cases, such as power failure or operational defects, it may be desirable to lower the load manually.



NOTE

Excessive use of effort or an independent downward movement indicate a damaged actuator. The MAGDRIVE™ must not be run any more. Immediately inform the manufacturer that performs the inspection.

5.3 Emergency shutdown

1. Pull out the plug of the cable that connects the linear actuator to the control unit.



NOTE

The MAGDRIVE™ does not have an on / off switch and must be separated from the power supply to the control unit. Only this measure will de-energize the MAGDRIVE™.

Patient lifters

An emergency off switch is essential for patient lifters.



NOTE

The emergency shut-off switch must be fitted by the executor.

6.0 Installation and Initial Start-Up

This chapter is intended for technicians and those doing the further processing. It provides all the information that you need to assemble, connect and start up the linear actuator MAGDRIVE™.

6.1 Preparation

Good preparation is part of efficient installation and start-up. This includes, among other things, deciding on a location and having an energy source ready.

6.1.1 Transport



NOTE

The linear actuator must be examined for damage on delivery. Any transit damage is to be notified to the carrier and the manufacturer immediately and in writing.

The linear actuator MAGDRIVE™ is delivered as a unit in a box or on pallets. Instruct a carrier to ship the linear actuator.

Return to the manufacturer

Prepare the linear actuator for transport as follows:

1. Dismantle the linear actuator (↳ **8.2 Dismantling, page 19**)
2. Pack the linear actuator carefully.



NOTE

The storage conditions also apply to the transport (↳ **8.3 Storage, page 19**). You can find important information on weight, dimensions etc. in the technical data in the appendix (↳ **9.1 Technical data, page 20**) and the associated datasheets.

6.1.2 Check items in shipment

The linear actuator comprises:

- a complete actuator unit comprising drive, motor and linear unit
- a cable with a low-voltage plug

6.1.3 Power supply

The linear actuator MAGDRIVE™ runs solely on electricity. Observe the connection values in the appendix of this manual (↳ **9.1.1 Equipment and operating data, page 20**) or the associated datasheets.

6.2 Installation and connections

Installing the linear actuator MAGDRIVE™ on other elements involves taking into account special requirements of different applications.

The linear actuator MAGDRIVE™ is fixed to two elements via the fork head and hinge head.

The following sections show how to set up and align the linear actuator MAGDRIVE™, as well as the interfaces and connections.

6.2.1 Set-up and adjustment

In setting up and aligning the linear actuator MAGDRIVE™ the following points must be observed.

Make sure that

- the fork head and hinge head and the application elements are connected with fastening bolts (only use fastening bolts! Screws and such like may not be used due to pre-tensioning, poor positioning or flexing).
- the acting force also works centrally on the push tube (lateral forces or those that exert a torque on the linear unit can destroy the linear actuator),
- the linear actuator is not obstructed in any way in the entire stroke area.
- the cables are not pinched or caught or subject to tension stress,
- you never loosen screws on the MAGDRIVE™ or try to open the linear drive MAGDRIVE™ (Ewellix rejects all warranty claims if screws on the MAGDRIVE™ have been manipulated).

6.2.2 Interfaces and Connections

You can find the nominal values in the appendix (↳ **9.1 Technical Data, page 20**) or associated datasheets. Check that all interfaces and connections have been mounted and/or connected correctly.

- Interfaces for the application fixed to the fork head and hinge head
- Connection to an appropriate control unit (↳ **4.3.2 Accessories, page 12**)
- Connection to an appropriate operating unit (↳ **4.3.2 Accessories, page 12**)

6.2.3 Installation

⚠ WARNING

Risk of hand injuries when the motor is running due to clamping on the push tube's fork head. If the fork head is not installed in the device there is a turning movement. Do not let any object or person come into contact with the push tube's fork head while the motor is running. Hold the MAGDRIVE™ only by the tube casing.

Proceed as follows for installation:

1. Secure the elements that you want to connect the linear actuator to, so that you can place the MAGDRIVE™ between them.
2. Connect the fork head and the hinge head with each element of the application
3. Mount the elements on the fork head and on the hinge head with fastening bolts



NOTE

Only use fastening bolts; screws and such like may not be used due to pre-tensioning, poor positioning or flexing. The fastening bolts are not supplied. The bore dimensions can be found in the 9.2 Plans and diagrams, page 20 section or the associated datasheets. Please ensure that the connection cannot become loose unintentionally.



NOTE

Neither lateral forces nor a torque may affect the linear actuator.

4. Connect the linear actuator MAGDRIVE™ with the matching control unit by connecting the plug with the motor output of the control unit.
5. Pull the low voltage plug out of the corresponding control unit.
6. Connect the corresponding operating element to the corresponding control unit (see relevant operating instructions).
7. Connect the corresponding control unit to the mains supply (see applicable operating instructions).

Now you can operate the linear drive in accordance with the relevant operating instructions of the corresponding control unit.

Third-party control units

All control units that have not been authorized by Ewellix for MAGDRIVE™ are considered to be third-party devices. When using a third-party control unit Ewellix does not accept liability for any damage incurred. The following list includes, without guaranteeing completeness, additional points that must be observed.

The third-party control unit must:

- have an over-current circuit breaker,
- the over-current circuit breaker must be deactivated for 250 ms when switched on,
- switch off the linear actuator if the power exceeds 8.5 A for 50 ms,
- prevent the maximum operating time from being exceeded.

6.3 Initial Start-Up

Perform the installation check before you start up the linear actuator for the first time MAGDRIVE™.

6.3.1 Installation Check

⚠ WARNING

Warning for risk of crushing and damage to the MAGDRIVE™ caused by static and dynamic overloading of the linear actuator. When driving against fixed objects the impact of the force can cause personal injury. Make sure that there are no persons or fixed objects present in the danger zone during the stroke.

- Note the maximum permissible operating data in the appendix (↳ **9.1.1 Equipment and operating data, page 20**) or the associated datasheets
- Note the type plate of the linear actuator

Check the following points before the initial start-up:

- No lateral forces on the push tube
- No torque on the push tube
- Fixing bolts secured on the fork head and hinge head
- Entire stroke area not obstructed, so that the linear actuator cannot be driven onto a fixed object
- Electrical power supply secured via a Ewellix control unit (low-voltage plug correctly connected with Ewellix control unit)
- Ewellix operating element connected to the Ewellix control unit

6.3.2 Initial Start-Up

After the installation check has been completed, you can start up the linear actuator MAGDRIVE™: To do so, press the corresponding operating button of the Ewellix operating element.

7.0 Maintenance, Clearing malfunctions, Repairs

This chapter is intended for technicians and those doing the further processing. It provides you with all the information you need for maintaining, clearing malfunctions and carrying out repairs on the linear actuator MAGDRIVE™.

7.1 Maintenance

Maintenance includes all operations which keep the linear actuator fully functional.

These operations include inspections, replacing consumables and cleaning.

7.1.1 Maintenance plan

The linear actuator MAGDRIVE™ is virtually maintenance-free for the full duration of its service life (↳ **9.1.1 Equipment and operating data, page 20**). The connection cables and linear actuator have to be checked for wear and tear at regular intervals.

7.1.2 Cleaning

⚠ CAUTION

Please note that the MAGDRIVE™ can be damaged by water or other fluids. MAGDRIVE™ is only protected to IPX0 or, as an option, IPX4S (sprayed water). In any case, the MAGDRIVE™ must be prevented from being exposed to sprayed water when moving in or out.

Observe the following points when cleaning:

- Clean soiled parts immediately
- Use a damp cloth
- Wash water including added chemicals must be pH-neutral.
- Acidic or alkaline wash water can destroy metallic and plastic parts.

Medical area

- Hand-wash disinfection exclusively with isopropyl alcohol

Emergency lowering

For applications with emergency lowering, the following must also be observed:

- Disinfection and cleaning the emergency lowering mechanism only using propylalcohol
- The emergency lowering mechanism may not be treated with oil, grease or other lubricants
- If the emergency lowering does not work properly, inform the manufacturer of the application immediately



NOTE

Other cleaners apart from those stated (e.g. high-pressure steam cleaners etc.) damage the linear actuator. Always contact the manufacturer if you want to use other cleaning agents.

7.2 Malfunctions

Any faults occurring in the linear actuator MAGDRIVE™ may only be rectified by a technician authorized by the manufacturer. In this case the MAGDRIVE™ must be removed from service (↳ **8.1 Shutting down, page 19**) and sent to Ewellix (↳ **6.1.1 Transport, page 14**).

In the following sections, you will find hints on how you can recognize, remedy or handle malfunctions.



NOTE

In any case, immediately inform customer service (↳ **2.2 Manufacturer Address, page 7**) if the fault cannot be rectified on the basis of the following instructions.

IMPORTANT: For reasons of safety the MAGDRIVE™ may not be opened and the screws on the linear actuator MAGDRIVE™ may not be manipulated. The warranty is made void by such intervention.

7.2.1 Recognizing malfunctions

1 – Linear actuator MAGDRIVE™ will not move

Hypothesis 1-A

No supply voltage or absence of plug contact

1. Insert the low-voltage plug of the MAGDRIVE™ into the Ewellix control unit
2. Plug the Ewellix control unit's mains cable into a mains socket.
3. Connect the operating element to the corresponding connection of the control unit.

MAGDRIVE™ Does it move now?

Yes: ↳ **5.0 Normal Operation, page 13**

No: **Hypothesis 1-B**

Hypothesis 1-B

Motor cable and/or the operating unit cable, and/or the mains cable of the control unit defective

1. Check the motor cable and/or the operating unit cable, and/or the mains cable of the control unit.

Motor cable and/or the operating unit cable, and/or the mains cable of the control unit damaged?

Yes: ↳ **2.2 Manufacturer Address, page 7**

No: **Hypothesis 1-C**

Hypothesis 1-C

Obstacle is obstructing the MAGDRIVE™

1. Remove all objects that impede the stroke.

MAGDRIVE™ Does it move now?

Yes: ↳ **5.0 Normal operation, page 13**

No: **Hypothesis 1-D**

Hypothesis 1-D

Wrong control unit

1. Check the type plate of the control unit.

Is the manufacturer of the control unit Ewellix and is it approved for the MAGDRIVE™?

Yes: **Hypothesis 1-E**

No: Replace control unit

Hypothesis 1-E

Incorrect useful load

1. Check the type plate of the linear actuator.
2. Measure the static or dynamic load.

Has the useful load been exceeded (↳ **9.1 Technical data, page 20**)?

Yes: ↳ **2.2 Manufacturer address, page 7**

No: **Hypothesis 1-F**

Hypothesis 1-F

Control unit defective

1. Carry out the troubleshooting procedure for the Ewellix control unit.

Is the Ewellix control unit faulty?

Yes: Replace control unit

No: **Hypothesis 1-G**

Hypothesis 1-G

Service life exceeded

Is the linear actuator MAGDRIVE™ older than 10 years or has it carried out more than 10,000 double strokes at 200 mm stroke length?

Yes: ↳ **2.2 Manufacturer address, page 7**

No: **Hypothesis 1-H**

Hypothesis 1-H

The linear actuator cannot be made to move by any of the measures listed above

1. Contact the manufacturer immediately (↳ **2.2 Manufacturer Address, page 7**).

2 – Linear actuator cannot be operated**Hypothesis 2-A**

Ewellix operating element defective

1. Check the type plate of the operating element.

Is the manufacturer of the operating elements Ewellix and is it approved for the MAGDRIVE™?

Yes: ↳ **2.2 Manufacturer Address, page 7**

No: Replace operating element

3 – Load cannot be lifted**Hypothesis 3-A**

Spindle nut defective

1. Remove all objects that impede the stroke.
2. Remove all loads on the elements.

Does the linear actuator move normally?

Yes: ↳ **5.0 Normal operation, page 13**

No: ↳ **2.2 Manufacturer Address, page 7**

4 – Greatly reduced speed**Hypothesis 4-A**

Motor, gears or spindle nut faulty

1. Remove all objects that impede the stroke.
2. Remove all loads on the elements.

Is the speed normal again?

Yes: ↳ **5.0 Normal operation, page 13**

No: ↳ **2.2 Manufacturer Address, page 7**

5 – Greatly increased running noises**Hypothesis 5-A**

Motor, gears or spindle nut faulty

1. Remove all objects that impede the stroke.
2. Remove all loads on the elements.

Still elevated running noises?

Yes: ↳ **5.0 Normal operation, page 13**

No: ↳ **2.2 Manufacturer Address, page 7**

6 – Increased play between push tube and tube casing**Diagnosis 6-A**

Sliding elements worn, immediately inform customer service (↳ 2.2 Manufacturer address, page 7).

7.3 Repair

The linear actuator MAGDRIVE™ may only be opened by the manufacturer. In any case, contact customer service (↳ **2.2 Manufacturer Address, page 7**).

Emergency lowering

If excessive force is required for the turning movement or it is very easy to move under nominal load (i.e. independent lowering movement by linear actuator) the linear actuator may no longer be operated. The manufacturer must examine the linear actuator MAGDRIVE™. Immediately inform customer service (↳ **2.2 Manufacturer address, page 7**).

8.0 Removing from service, dismantling and disposal

This chapter is intended for technicians and those doing the further processing. It provides you with all the information needed to remove the linear actuator MAGDRIVE™ from service, dismantle it and dispose of it.

8.1 Shutting down

The linear actuator MAGDRIVE™ is to be removed from service in the following sequence:

1. De-energize the linear actuator by unplugging the mains plug of the control unit from the power outlet.
2. Secure the elements in such a way that there is no pulling or pushing force resting on the fork head and hinge head.
3. Loosen the lock that connects the low voltage plug of the MAGDRIVE™ with the Ewellix control unit.
4. Pull the low voltage plug out of the Ewellix control unit.

Afterwards you can dismantle or reinstall the MAGDRIVE™.

8.2 Dismantling

Before you start dismantling, put the linear actuator MAGDRIVE™ out of operation (↳ **8.1 Shutting down, page 19**). The linear actuator MAGDRIVE™ is to be dismantled in the following sequence:

1. Ensure that there is no pressure acting on the fork head and hinge head.
2. Loosen the fastening bolts from the fastening bracket on the fork head and hinge head
3. Remove the fastening bolt
4. Separate the linear actuator from the elements

Afterwards, you can prepare the MAGDRIVE™ for shipping (↳ **6.1.1 Transport, page 14**) or store or dispose of it as described in the following sections.

8.3 Storage

For storage, pack the MAGDRIVE™ in its original packaging. Observe the following values when selecting a storage location:

- Ambient temperature: -10 °C to +40 °C
- Atmospheric humidity: up to 95%
-

8.4 Disposal

The linear actuator is primarily made from recyclable materials. Specialized companies can separate the recyclable materials and therefore minimize the quantity of materials requiring disposal.

The linear actuator must be disposed of in a technically correct manner in accordance with local regulations. The plastic parts are marked with material specifications on the actual parts (except some of the smallest parts).

Please find dismantling instructions and shipping requirements in the relevant sections.

9.0 Appendix

Technical data sheets

PUB NUM IL-07020-EN magdrive datasheet

For further technical information please contact Ewellix.

Magdrive

Linear actuator

Benefits

- Slim design
- Aluminium profile
- In-line actuator
- Quiet operation
- High push load



Technical data

	Unit	MD22/MD24	MD23/MD25
Rated push load	N	6 000	6 000
Rated pull load	N	200 (static only)	6 000
Speed (full load to no load)	mm/s	8,5 to 15	8,5 to 15
Stroke	mm	50 to 700	50 to 700
Retracted length	mm	S+465	S+465
Voltage	V DC	24	24
Power consumption	W	N/A	N/A
Current consumption	A	7	7
Duty cycle	%	10 (1/9)	10 (1/9)
Ambient temperature	°C	+10 to +40	+10 to +40
Type of protection	IP	x0/x4S	x0/x4S
Weight	kg	5,0	5,0
Color	–	Colorless anodized	Colorless anodized

Dimensional drawing

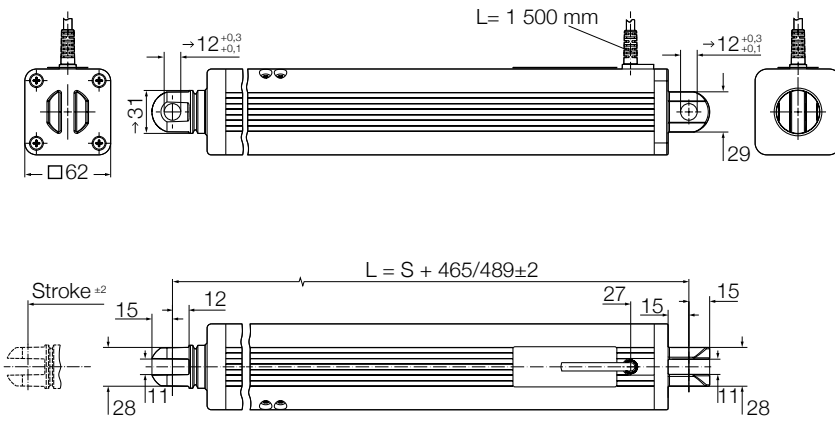

Plastic bushing for forkhead (hinge delivered separately)

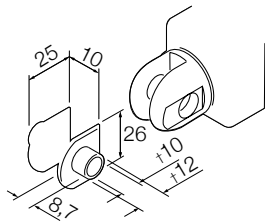

Orientation of rear attachment

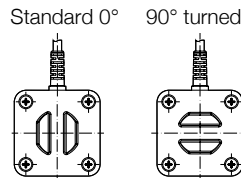

Legend:
S = stroke
L = retracted length

Connecting diagrams

24 V DC

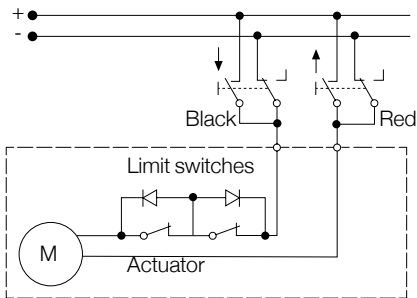

24 V DC (DIN8 plug)

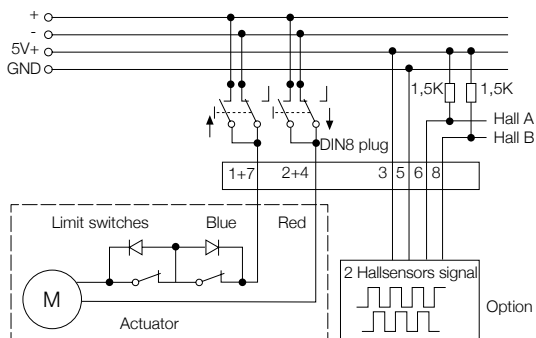

Suitable control units and accessories

MAGDRIVE	Control units			
	SCU	VCU	BCU	MCU
Operating switches				
EHA 1				•
EHA 3	•	•	•	
STJ	•	•	•	
STF				•
STA				•
STE	•	•	•	

Hand switch

Foot switch

Desk switch

Performance diagrams

Speed-load diagram

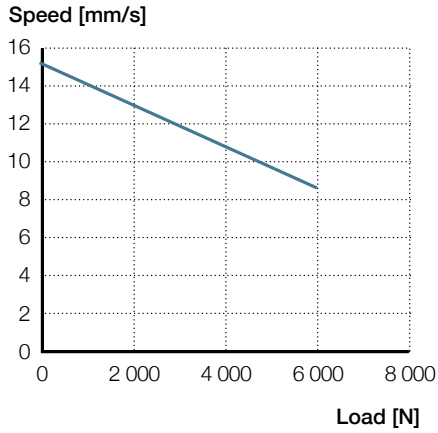

Current-load diagram

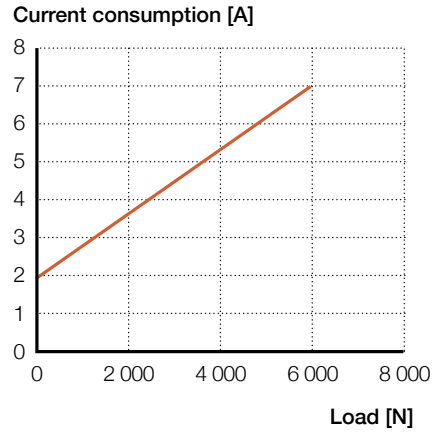

Safety factor load conditions

Push load diagram

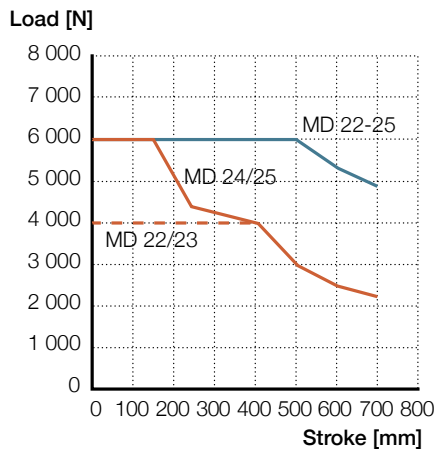

Pull load diagram MD23

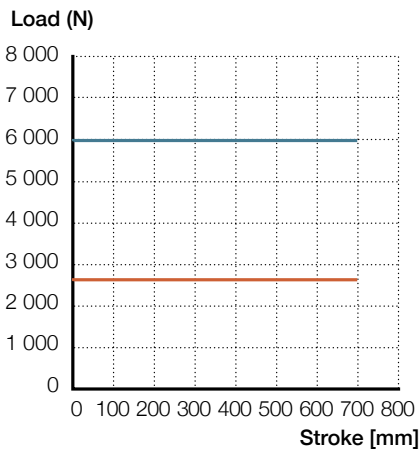

Pull load diagram MD25 (6 000 N)

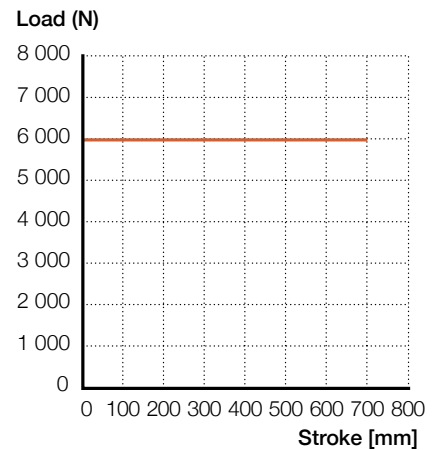

— Safety factor S=2
— Safety factor according UL60601-1, IEC60601-1

— Safety factor S=4
— Safety factor according UL60601-1, IEC60601-1

— Safety factor according UL60601-1, IEC60601-1

Ordering key

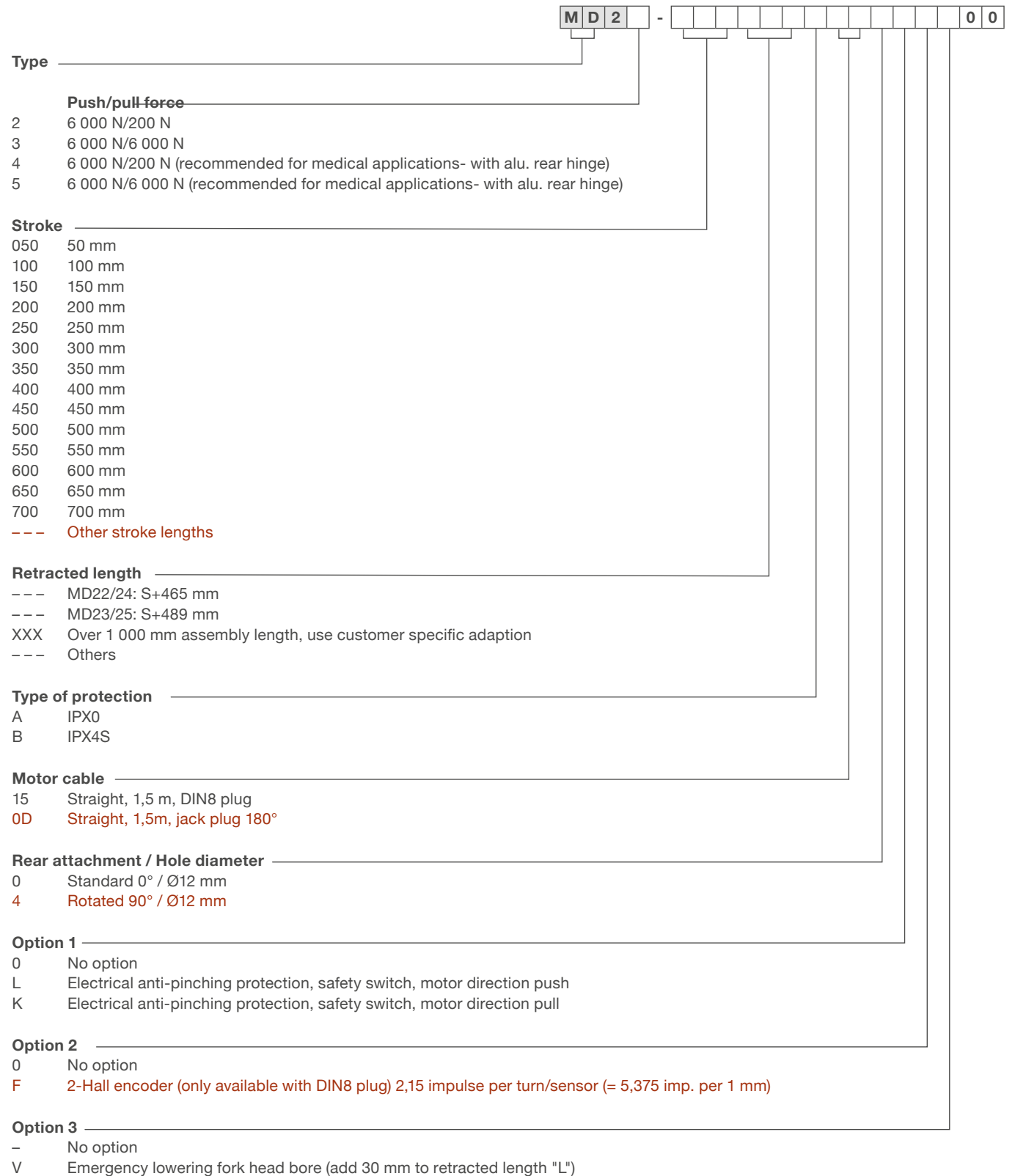

Options shown in red are only available on request. Contact Ewellix for more information on minimum quantities and additional costs.



ewellix.com

© Ewellix

All contents of this publication are the property of Ewellix, and may not be reproduced or given to third parties (even extracts) without permission. Although great care has been taken in the production of this catalog, Ewellix does not take any responsibility for damage or other loss resulting from omissions or typographical errors. The photo may differ slightly in appearance from the actual product. Due to continuous improvements being made in our products, the product's appearance and specifications are subject to change without notice.

PUB NUM TC-08031-EN-April 2020